

base trifásica
de superficie
ficha técnica
datasheet

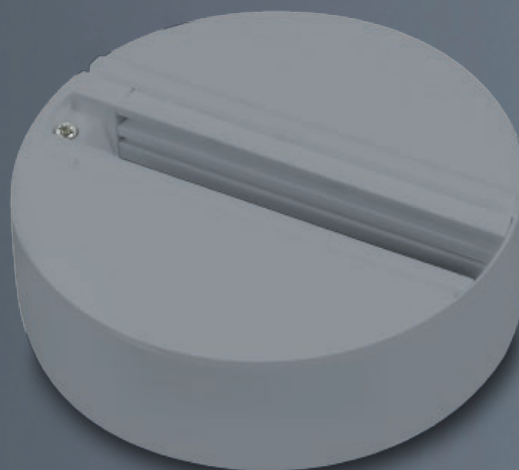

ref. 5550857

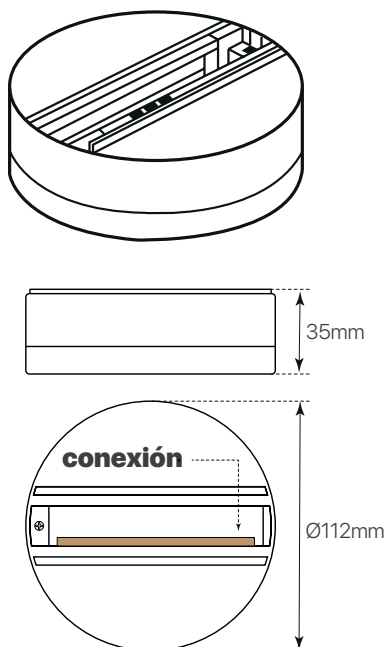

Nombre / Name	Base trifásica de superficie blanca track
Referencia / Reference	5550857
Materiales / Materials	PC
Difusor / Diffuser	-
Potencia / Power	-
Temperatura de color / Color temperature	-
Flujo luminoso / Luminous flux	-
Dimable / Dimmable	-
Ángulo de apertura / Beam angle	-
Ángulo de inclinación / Inclination angle	-
IP	20
IK	-
F.P	-
UGR	-
IRC	-
Chip	-
Driver	-
Vida media (duración) / Average life	-
Clase energética / Energy class	-
Aislamiento eléctrico / Electrical isolation	-
Colores / Colors	Gris / Grey
Medida exterior / Product size	Ø112mm x 35mm
Medidas de corte / Cutting measurements	-
Tª (ambiente/trabajo) / Tª (environment/work)	-
Input	-
Output	-
Frecuencia / Frequency	-
Peso / Weight	108grs
Certificados / Certificates	CE RoHS
Garantía / Warranty	2 años / 2 years